

# HOME pro

cabinets to go

## Cabinet Installation Guide

### **Step 1 – You will need these tools**

- Carpenters level (24” – 48”)
- Slot, Philips and Robertson screwdrivers
- Robertson screws #8 x 2 1/2” (cabinet to wall) with 3 1/2” cup washers
- Robertson screws #8 x 1 1/8” (cabinet to cabinet) with 3 1/2” cup washers
- Claw hammer
- 3/8” Electric or Cordless drill with bits
- Table saw (for cutting fillers)
- Miter saw (if installing crown)
- Jig saw (for cut-outs)
- “C” clamps or Quick-Grip clamps
- Metal square
- Tape measure
- Wood shims
- ▶ If you’re remodeling you’ll also need:
  - Crowbar
  - Patching plaster
  - Sandpaper

### **Step 2 – Prepare the area**

- Begin your room preparation by disconnecting and removing all appliances, furnishings and accessories from the installation area. Tie up any hang-down light fixtures that might get in the way.

### **Step 3 – Remove old construction**

- If you are remodeling an older area you will need to remove old woodwork. Most will just require removing screws. You may need to use your crowbar and claw hammer to gently pry loose all old countertops, base cabinets, baseboards, wall cabinets, chair rails and other moldings from wall and floor areas.

### **Step 4 – Plan electrical needs**

- If you’re changing the location of appliances, plan for new outlets nearby. If you’re installing kitchen cabinets check to see if the range, oven and vented hood will require additional wiring. Plan for countertop outlets. Make notes of all electrical changes on your layout and enlist the services of a dependable electrician.

### **Step 5 – Plan plumbing requirements**

- Will your new kitchen have a built-in dishwasher? A refrigerator that makes its own ice cubes? Will the sink or basin be relocated? Will additional sinks or basins be added? Again, using your layout, indicate plumbing changes and have a reliable plumber rough them in now.

**Step 6 – Plan floor coverings**

- This is the proper time to have the flooring prepared for cabinet installation. Consult with your flooring expert to find out whether new cabinets should be installed directly over sub-flooring or over the new surface. Be sure sub-flooring is installed with proper spiral-edged flooring nails or screws to prevent surface popping, or as per flooring specs. Note: Gem Cabinets does not recommend working on a finished floor when installing cabinets.

**Step 7 – Find the high point**

- Most floors are not level. They have high and low points and sometimes these can be noted merely by looking. To be sure of your floor's high point, lay a straight section of 2x4 across what you think may be the high point and butt it up against the baseboard or wall. Using a level, draw a line along the edge of the 2x4 onto the baseboard or wall. Continue the line around the entire room until you are certain of the high point.

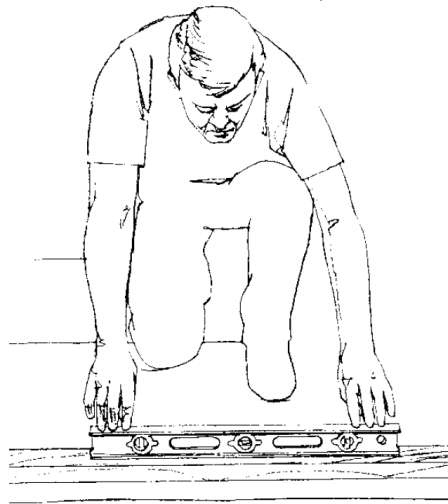

**Step 8 – Measure for base cabinets**

- Check base cabinet height and measure up exactly from the room's high point then carefully draw a level horizontal line around the room to represent the top height of your base cabinets without countertops. (Typically 34 5/8" or 34 7/8")

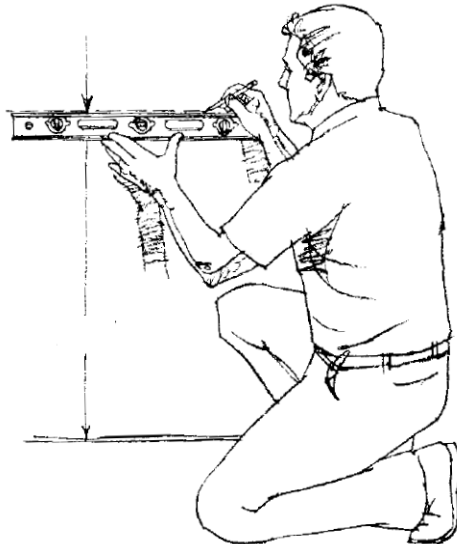

**Step 9 – Measure for Wall cabinets**

- Measure up exactly 84", 90" or 96" (depending on cabinet height ordered) from the room's high point and draw another level horizontal line to indicate the top height of the wall cabinets.

**Step 10 – Check and mark sizes and locations**

- Make sure all cabinets and appliances are the size and specifications ordered. Mark the locations of all cabinets directly onto the walls. Make sure all vents; plumbing and electrical outlets are where they should be.
- Note: Oven cut-outs are much easier when you can lay the oven cabinets on the floor rather than in place.

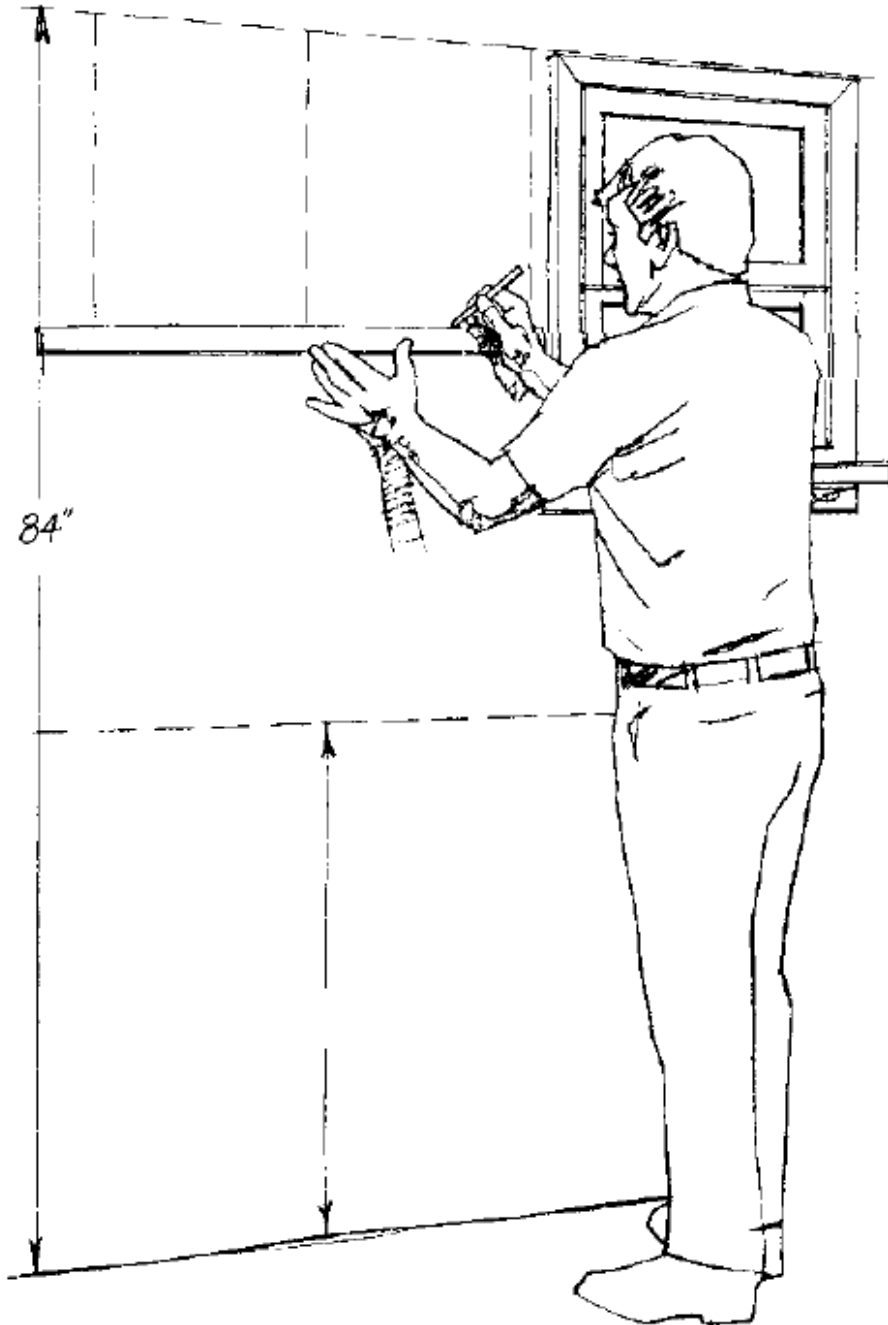

**Step 11 - Locate studs**

- All cabinets must be attached securely with screws through the walls to the centers of studs. To locate studs, tap walls lightly with a hammer until you hear a sound that is not hollow. Drive in a thin nail to confirm the stud's location. Then probe right and left to locate the exact center. Once you've found one on each wall, the others are easy since they are normally 16" apart. Mark each stud's center along wall areas where cabinets will be installed. There are also electronic stud finders available at many hardware stores.

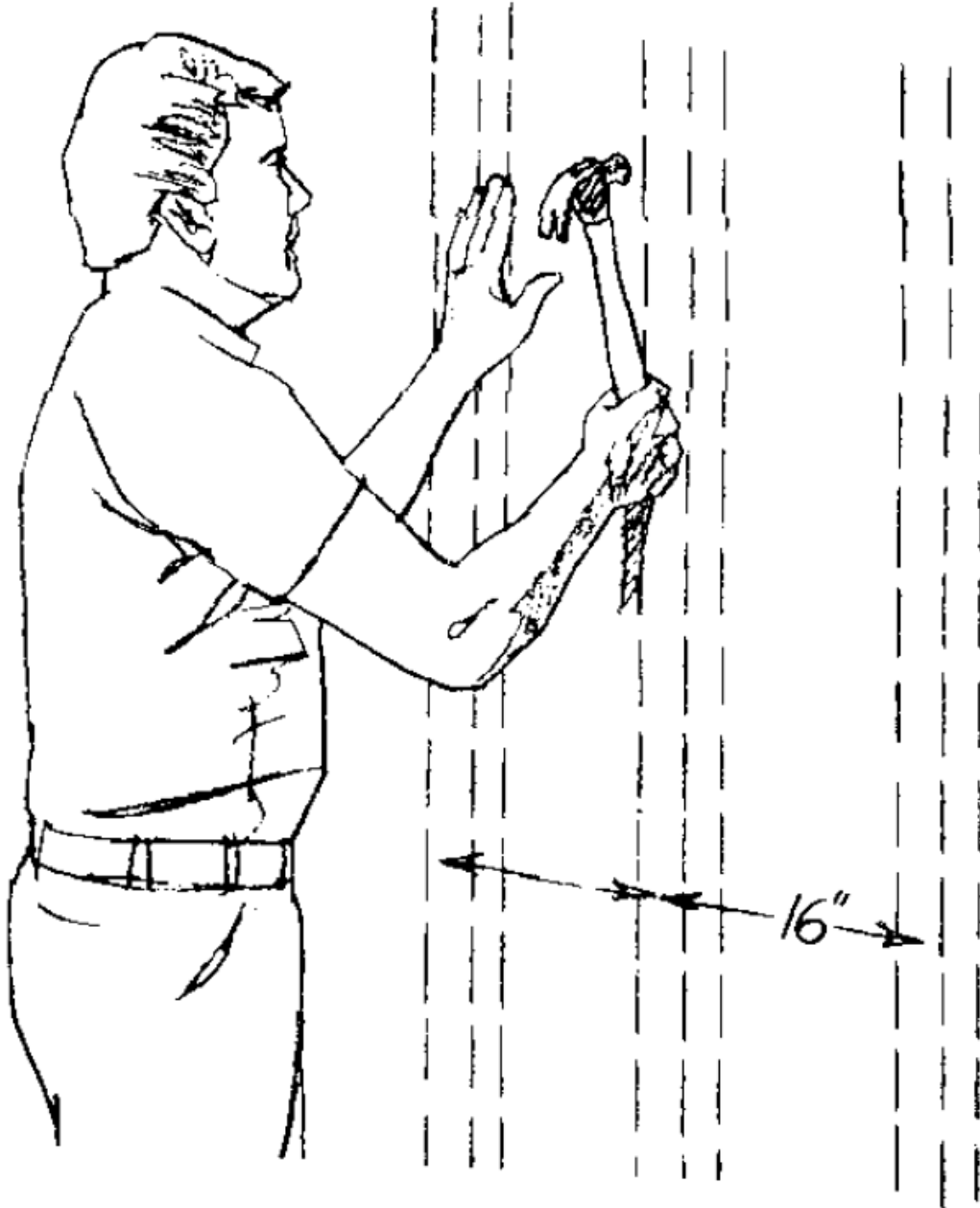

**Step 12 - Repair walls**

- Clean out plaster cracks and holes in walls and soffits. Fill with patching plaster, sanding the surface when dry. Remove protruding nails and obvious high spots on walls.

**Step 13 – Install a corner cabinet**

- Your cabinets should be installed working from the top down to give more working space and to make the backs of wall units more accessible. For ease of installation, remove all doors from cabinets by un-clipping the hinges using the lever at the back of each hinge then number them so they will be returned to the proper cabinets. To begin installation, place a corner wall cabinet with its top along your “cabinet top” horizontal line. If you are working alone you may need to improvise a temporary support from 2 sections of 2x4. Mark the position of wall studs along the cabinets back exterior hanger rails, top and bottom. Pre-drill holes through cabinet back rails and fasten snugly on the wall. If any unit covers only one stud, it must be attached along the bottom rail as well.

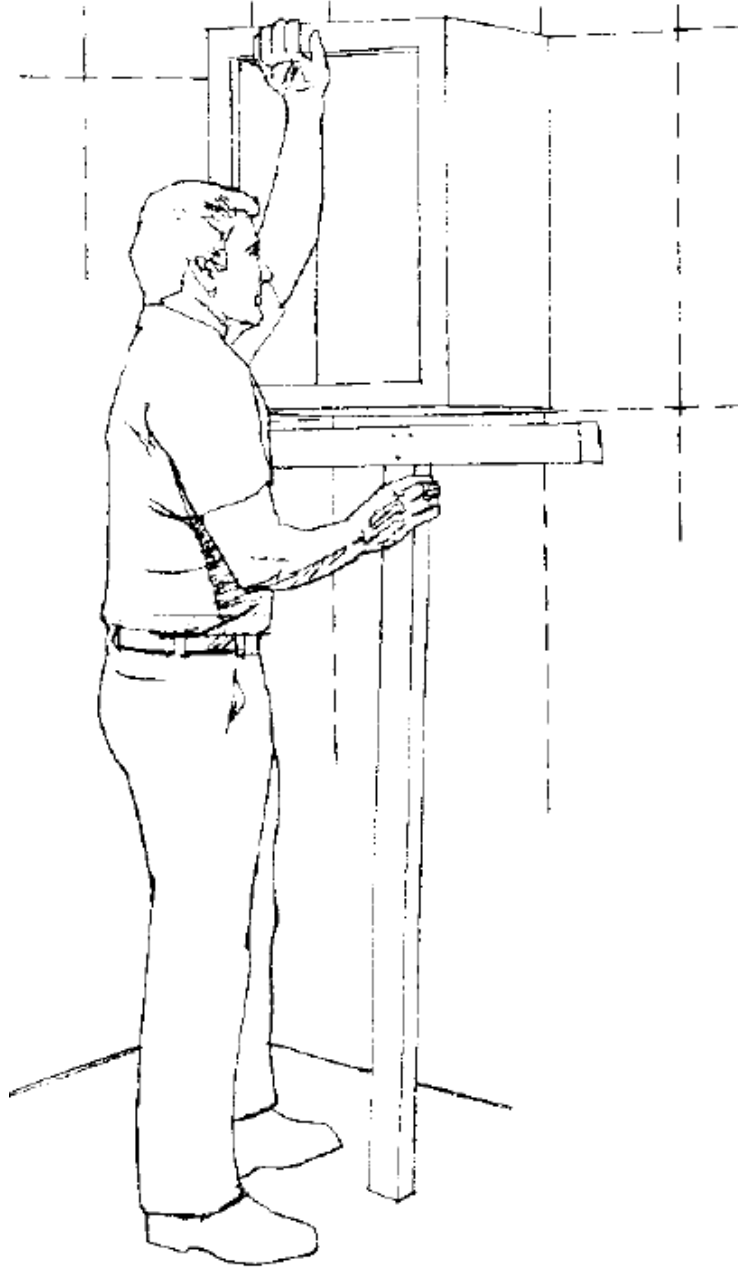

**Step 14 – Finish wall cabinet installations**

- Working progressively from one wall cabinet to the next, continue installation hanging the rest of the cabinets loosely. Shim the back edges of cabinets wherever the wall is uneven. Make sure all units are plumb and level and the gables line up with each other at the front.

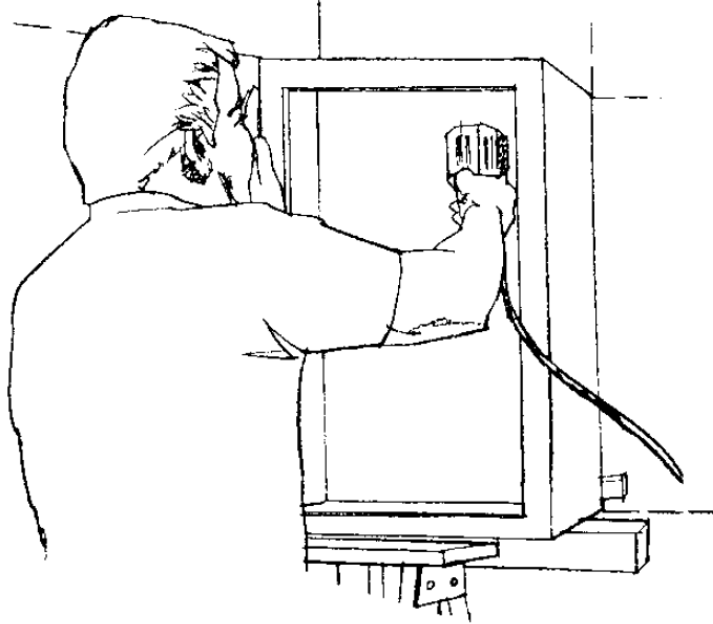

**Step 15 – Attach wall cabinets**

- Pull 2 adjoining wall units together at the gables and, using the clamps, draw the gables securely together near the upper and lower hinges. To protect the cabinet finish put masking tape on the face of the clamps before drawing them tight. Drill 2 holes through one gable and secure with screws and washers, making sure that the length of screws used doesn't exceed the combined width of the 2 gables. They should be Robertson #8 x 1 1/8" with a 3 1/2" cup washer, remember not to over-tighten.

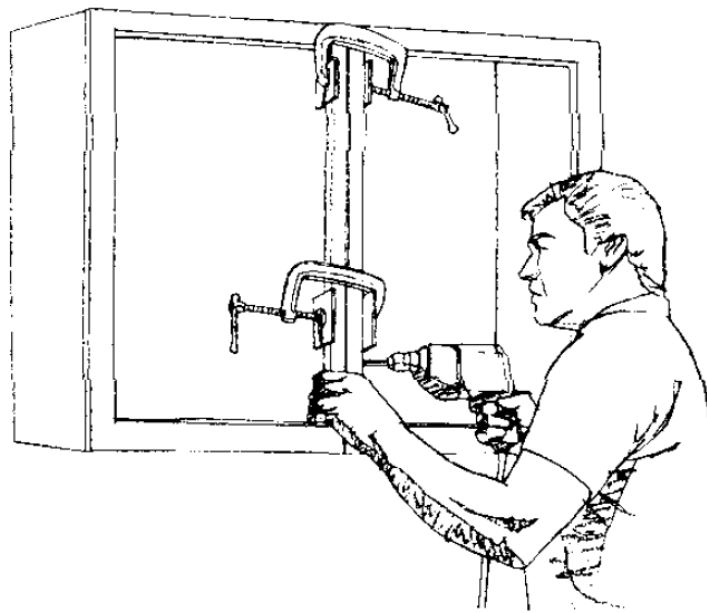

### **Step 16 – Attach fillers**

- Your cabinets are manufactured in 3” wide increments. Use wood fillers cut to proper length with a table saw to fit any dimensions less than 3”. Attach fillers through gables in the same manner as described in Step 15 for attaching one unit to the next. Always pre-drill the filler screw if the filler is less than 1” to prevent splitting.

### **Step 17 – Tighten cabinets**

- After all wall cabinets have been hung in place, fastened together and aligned plumb and level, securely tighten the hanging rail screws into the studs.

### **Step 18 – Label drawers**

- Drawers for base units are custom fitted at the factory. Before removing from cabinets number and mark them so they will be returned to the proper cabinet upon completion of installation.

### **Step 19 – Install a base corner cabinet**

- Place a base corner cabinet along the horizontal base cabinet line. Wood shims under low spots may be necessary to position the cabinet level. Attach base cabinets to the wall following the same instructions for wall cabinets. Note: If you’re installing a lazy susan unit, attach it first to the adjoining unit(s) and install as one. Make sure the revolving apparatus functions properly before attaching joined units to wall. For peninsula installation trace the toe kick on the floor and secure a block under the cabinet to fasten the cabinet to. Note: the toe kick may come as a loose piece for some cabinets.

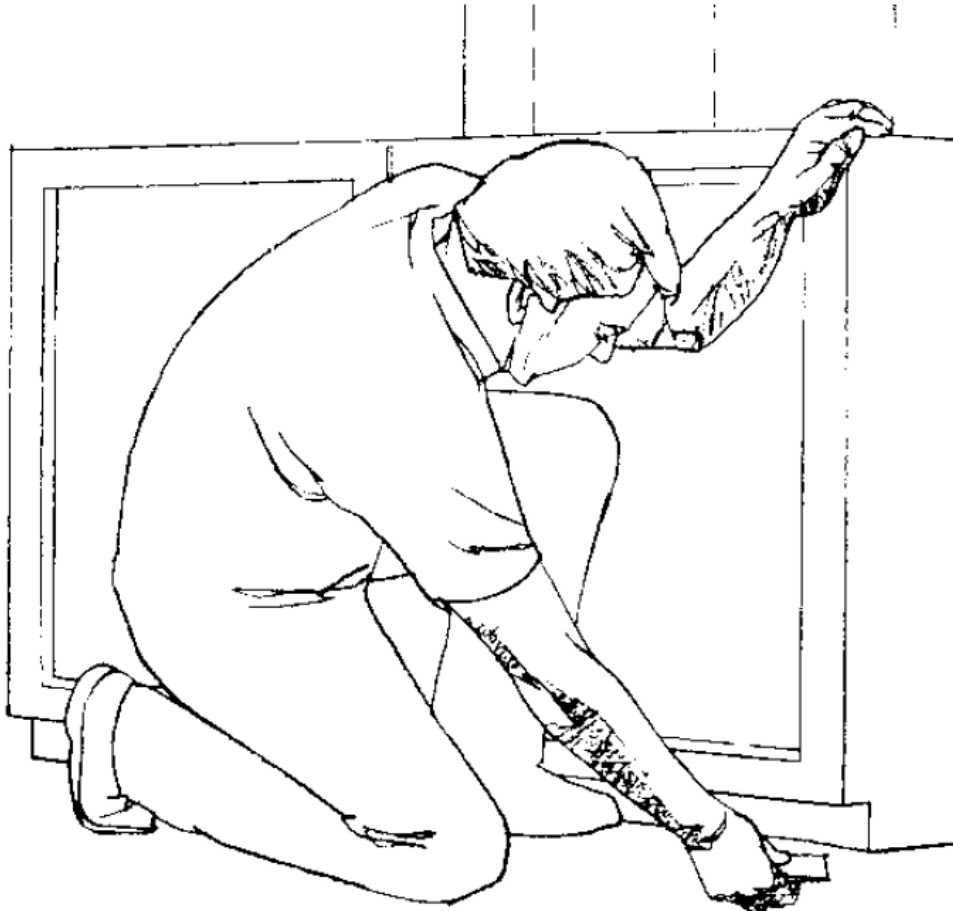

### **Step 20 – Complete base cabinet installation**

- Install all base cabinets following the same instructions as wall cabinets. After all base cabinets are fastened to the wall and level front to back, fasten the gables to one another in the same way described in Step 15. Attach fillers the same way as described in Step 16.

### **Step 21 – Attach doors**

- Attach doors to proper cabinets with the clips on the hinges. There is a tolerance in the hinges for proper door alignment. Doors should be adjusted level throughout the kitchen.

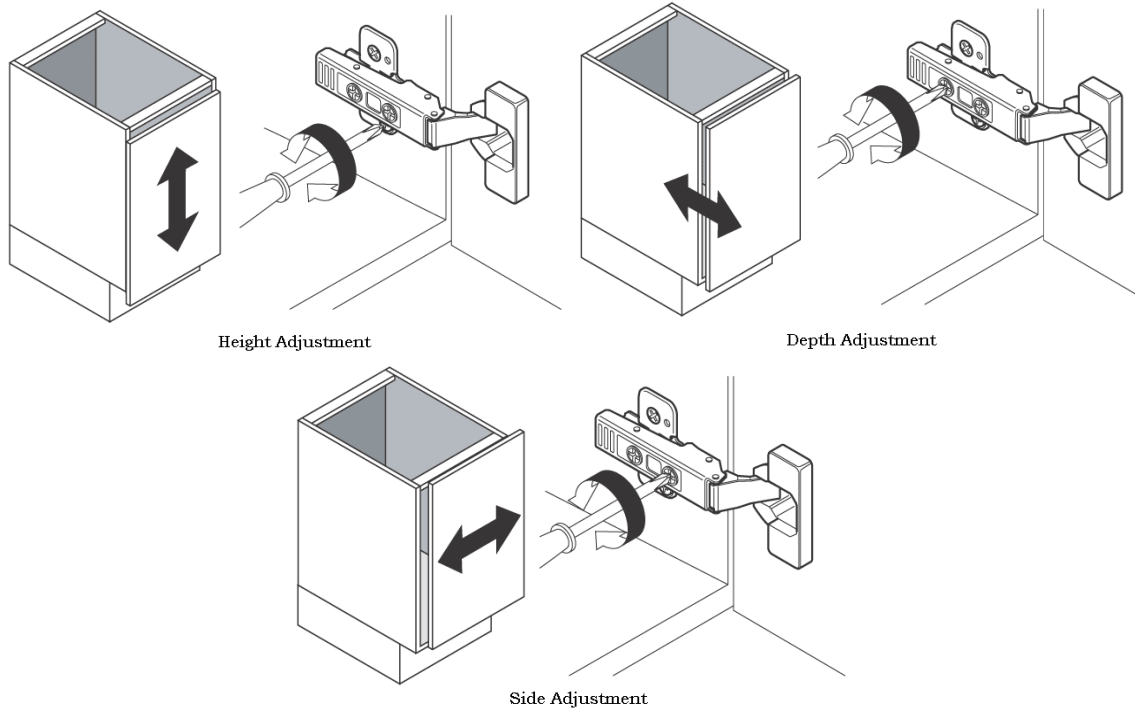

### **Step 22 – Shelf clips**

- Ensure that all shelf clips are installed so the weight of the shelf rests on the shelf support as shown. Failure to install clips properly may result in the shelf clip breaking. Check to see that shelf clips are installed in the center of the cabinet on the back wall and behind the center frame member of the cabinet.

